

Standard PCB Terminal Blocks

Range: PCB Terminal Blocks, Connectors and Fuse Holders

Part Number: AST0610804

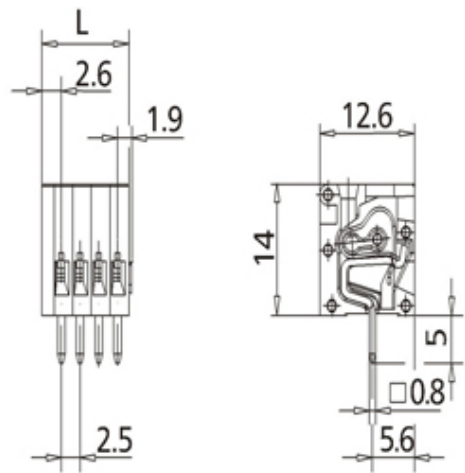
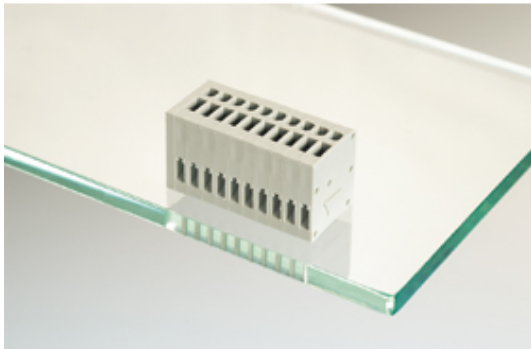

DESCRIPTION

8 Pole horizontal spring PCB terminal block 2.5mm pitch 9A 80V

Subject to technical modification without notice.

Typographical and other errors do not justify claim for damages.

SPECIFICATION

Type	Spring - Screwless
Connection Method	Tool operated
Mounting Type	Wave - through hole
Orientation	Horizontal
Join	End stackable
Pitch (mm)	2.5
Number of Poles	8
Min Wire Size (Sq mm)	0.08
Max Wire Size (Sq mm)	0.5
Max Current (A)	9
Max Voltage (V)	80
Height (mm)	14
Standard Colour	Grey
Width (mm)	12.6
Length (mm)	21.6
Solder Pin Length (mm)	5
PCB Hole Diameter (mm)	1.3
Comments	Pole sizes / no of ways not shown, please contact us for availability
IP Rating	20
Min Temperature Rating °C	20
Min Wire Size AWG	28
Pin Style	Solderable
Tracking Resistance CTI (v)	600