

# Standard PCB Terminal Blocks

Range: PCB Terminal Blocks, Connectors and Fuse Holders

Order Code: AST0611204

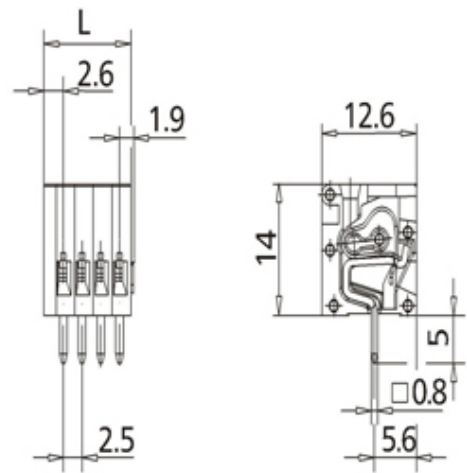
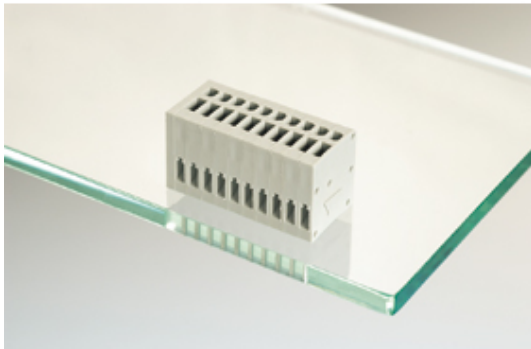

## DESCRIPTION

12 Pole horizontal spring PCB terminal block 2.5mm pitch 9A 80V

*Subject to technical modification without notice.*

*Typographical and other errors do not justify claim for damages.*

## SPECIFICATION

<b>Type</b>	Spring - Screwless
<b>Connection Method</b>	Tool operated
<b>Mounting Type</b>	Wave - through hole
<b>Orientation</b>	Horizontal
<b>Join</b>	End stackable
<b>Pitch (mm)</b>	2.5
<b>Number of Poles</b>	12
<b>Min Wire Size (Sq mm)</b>	0.08
<b>Max Wire Size (Sq mm)</b>	0.5
<b>Max Current (A)</b>	9
<b>Max Voltage (V)</b>	80
<b>Height (mm)</b>	14
<b>Standard Colour</b>	Grey
<b>Width (mm)</b>	12.6
<b>Length (mm)</b>	31.6
<b>Solder Pin Length (mm)</b>	5
<b>PCB Hole Diameter (mm)</b>	1.3
<b>Comments</b>	Pole sizes / no of ways not shown, please contact us for availability
<b>IP Rating</b>	20
<b>Min Temperature Rating °C</b>	20
<b>Min Wire Size AWG</b>	28
<b>Pin Style</b>	Solderable
<b>Tracking Resistance CTI (v)</b>	600