

Standard PCB Terminal Blocks

Range: PCB Terminal Blocks, Connectors and Fuse Holders

Order Code: AST1371004

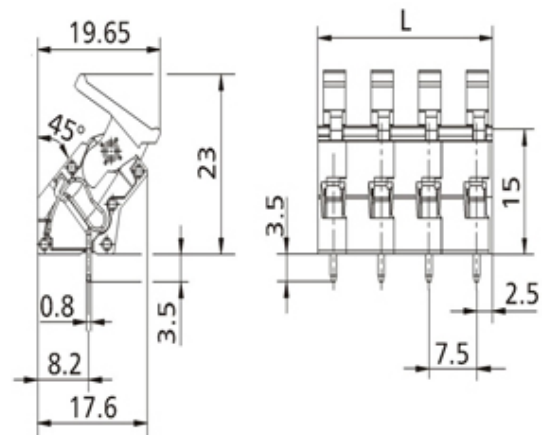
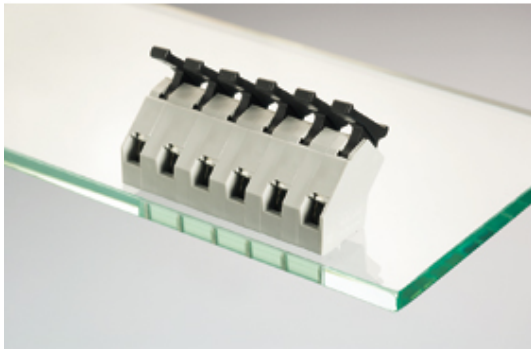

DESCRIPTION

10 Pole 45 degree spring PCB terminal block 7.5mm pitch 16A 750V

Subject to technical modification without notice.

Typographical and other errors do not justify claim for damages.

SPECIFICATION

Type	Spring - Screwless
Connection Method	Lever / Tool Less
Mounting Type	Wave - through hole
Orientation	45 Degree
Join	End stackable
Pitch (mm)	7.5
Number of Poles	10
Min Wire Size (Sq mm)	0.08
Max Wire Size (Sq mm)	2.5
Max Current (A)	16
Max Voltage (V)	750
Height (mm)	23
Standard Colour	Grey
Width (mm)	19.65
Length (mm)	72.5
Solder Pin Length (mm)	3.5
PCB Hole Diameter (mm)	1.4
Comments	Pole sizes / no of ways not shown, please contact us for availability
IP Rating	20
Min Temperature Rating °C	14
Min Wire Size AWG	28
Pin Style	Solderable
Tracking Resistance CTI (v)	600