

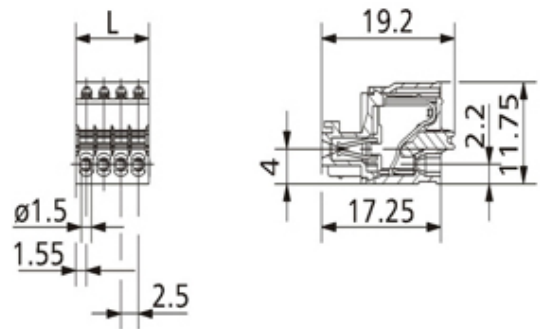

Plug and Socket PCB Terminal Blocks

Range: PCB Terminal Blocks, Connectors and Fuse Holders

Part Number: ASP0510806

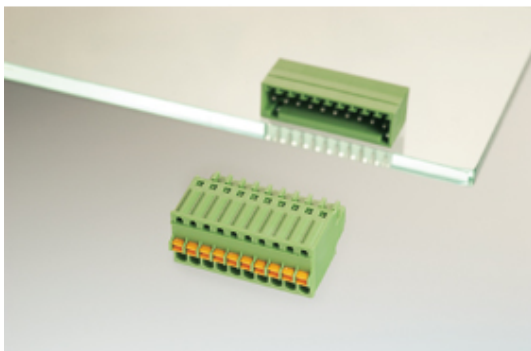

DESCRIPTION

8 Pole vertical spring PCB terminal block 2.5mm pitch 4A 130V

Subject to technical modification without notice.

Typographical and other errors do not justify claim for damages.

SPECIFICATION

Type	Cable mount - Female plug
Connection Method	Spring - Screwless
Mounting Type	Spring clamp
Orientation	Vertical
Join	Solid body non stackable
Pitch (mm)	2.5
Number of Poles	8
Min Wire Size (Sq mm)	0.08
Max Wire Size (Sq mm)	0.5
Max Current (A)	4
Max Voltage (V)	130
Height (mm)	11.75
Standard Colour	Green
Width (mm)	19.2
Length (mm)	21.2
Comments	Pole sizes / no of ways not shown, please contact us for availability
IP Rating	20
Min Temperature Rating °C	20
Min Wire Size AWG	28
Pin Style	Pluggable
Tracking Resistance CTI (v)	600

INDUSTRY ACCREDITATIONS

