

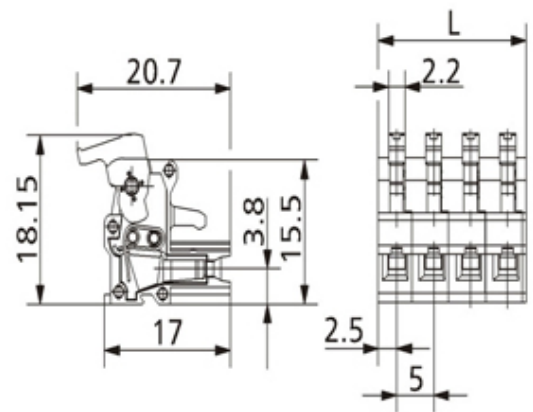

Plug and Socket PCB Terminal Blocks

Range: PCB Terminal Blocks, Connectors and Fuse Holders

Order Code: ASP0450322

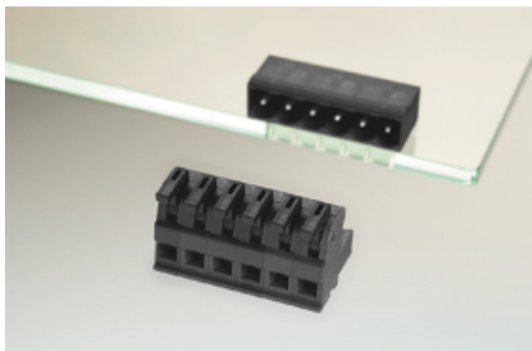

DESCRIPTION

3 Pole vertical spring PCB terminal block 5mm pitch 10A 250V

Subject to technical modification without notice.

Typographical and other errors do not justify claim for damages.

SPECIFICATION

Type	Cable mount - Female plug
Connection Method	Spring - Screwless
Mounting Type	Spring clamp
Orientation	Vertical
Join	End stackable
Pitch (mm)	5
Number of Poles	3
Min Wire Size (Sq mm)	0.08
Max Wire Size (Sq mm)	1
Max Current (A)	10
Max Voltage (V)	250
Height (mm)	18.15
Standard Colour	Black
Width (mm)	20.7
Length (mm)	15
Comments	Pole sizes / no of ways not shown, please contact us for availability
IP Rating	20
Min Temperature Rating °C	16
Min Wire Size AWG	28
Pin Style	Pluggable
Tracking Resistance CTI (v)	400

INDUSTRY ACCREDITATIONS

