

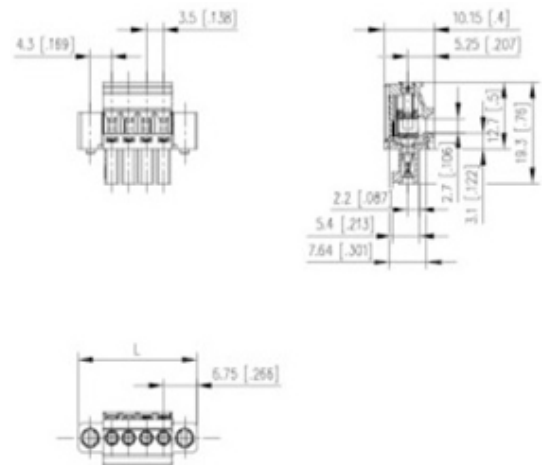

# Plug and Socket PCB Terminal Blocks

Range: PCB Terminal Blocks, Connectors and Fuse Holders

Order Code: 31634106



## DESCRIPTION

6 Pole horizontal screw female plug terminal block 3.5mm pitch 10A 130V

*Subject to technical modification without notice.*

*Typographical and other errors do not justify claim for damages.*

## SPECIFICATION

<b>Type</b>	Cable mount - Female plug
<b>Connection Method</b>	Screw
<b>Mounting Type</b>	Rising clamp
<b>Orientation</b>	Horizontal
<b>Join</b>	Solid body non stackable
<b>Pitch (mm)</b>	3.5
<b>Open/Closed/Screw/Flange</b>	Screw flange
<b>Number of Poles</b>	6
<b>Min Wire Size (Sq mm)</b>	0.08
<b>Max Wire Size (Sq mm)</b>	1.5
<b>Max Current (A)</b>	10
<b>Max Voltage (V)</b>	130
<b>Height (mm)</b>	19.3
<b>Standard Colour</b>	Black
<b>Width (mm)</b>	10.15
<b>Length (mm)</b>	31
<b>Comments</b>	Pole sizes / no of ways not shown, please contact us for availability
<b>IP Rating</b>	20
<b>Min Temperature Rating °C</b>	16
<b>Min Wire Size AWG</b>	28
<b>Pin Style</b>	Pluggable
<b>Tracking Resistance CTI (v)</b>	600

## INDUSTRY ACCREDITATIONS

