

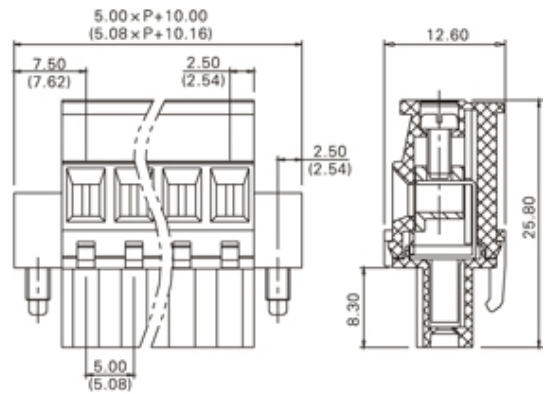

Pluggable Cable Mounting - Pluggable (Female)

Range: PCB Terminal Blocks, Connectors and Fuse Holders

Order Code: TLPSW-300RL-03P



DESCRIPTION

3 Pole Cable mount - Female plug Screw Rising clamp Horizontal 5.08mm pitch 16A(UL) 300V(UL)

Subject to technical modification without notice.

Typographical and other errors do not justify claim for damages.

SPECIFICATION

| | |
|----------------------------------|---|
| Type | Cable mount - Female plug |
| Connection Method | Screw |
| Mounting Type | Rising clamp |
| Orientation | Horizontal |
| Join | Solid body non stackable |
| Pitch (mm) | 5.08 |
| Open/Closed/Screw/Flange | Screw Flange |
| Number of Poles | 3 |
| Min Wire Size (Sq mm) | 0.08 |
| Max Wire Size (Sq mm) | 2.5 |
| Max Current (A) | 16A(UL) |
| Max Voltage (V) | 300V(UL) |
| Height (mm) | 25.8 |
| Standard Colour | Green |
| Width (mm) | 12.6 |
| Length (mm) | 25.4 |
| Body Material | PA66 V0 |
| Comments | Pole sizes / no of ways not shown, please contact us for availability |
| Min Temperature Rating °C | -40 |
| Max Temperature Rating °C | 105 |
| Min Wire Size AWG | 28 |
| Max Wire Size AWG | 12 |

INDUSTRY ACCREDITATIONS

