

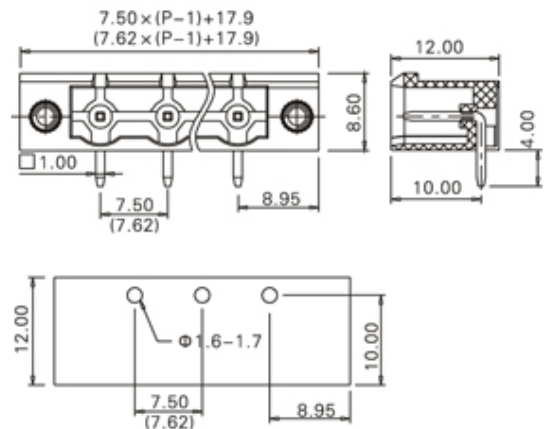

Pluggable Pin Header (Male) - Single Row PCB Header

Range: PCB Terminal Blocks, Connectors and Fuse Holders

Order Code: TLPHW-400R-05P



DESCRIPTION

5 Pole PCB mount - Male header Wave - through hole Horizontal 7.5mm pitch 16A(UL) 15A(VDE) 300V(UL) 450V(VDE)

Subject to technical modification without notice.

Typographical and other errors do not justify claim for damages.

SPECIFICATION

Type	PCB mount - Male header
Mounting Type	Wave - through hole
Orientation	Horizontal
Join	Solid body non stackable
Pitch (mm)	7.5
Open/Closed/Screw/Flange	Screw Flange
Number of Poles	5
Max Current (A)	16A(UL) 15A(VDE)
Max Voltage (V)	300V(UL) 450V(VDE)
Height (mm)	8.6
Standard Colour	Green
Width (mm)	12
Length (mm)	47.9
Solder Pin Length (mm)	4
PCB Hole Diameter (mm)	1.6-1.7
Body Material	PA66 V0
Comments	Pole sizes / no of ways not shown, please contact us for availability
Min Temperature Rating °C	-40
Max Temperature Rating °C	105

INDUSTRY ACCREDITATIONS

