

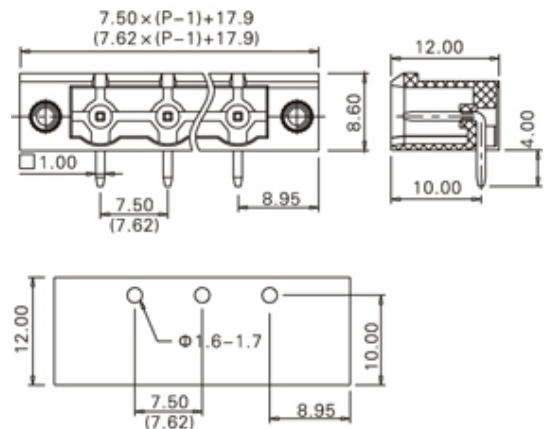

Pluggable Pin Header (Male) - Single Row PCB Header

Range: PCB Terminal Blocks, Connectors and Fuse Holders

Part Number: TLPHW-500R-10P



DESCRIPTION

10 Pole PCB mount - Male header Wave - through hole Horizontal 7.62mm pitch 16A(UL) 15A(VDE) 300V(UL) 450V(VDE)

*Subject to technical modification without notice.
Typographical and other errors do not justify claim for damages.*

SPECIFICATION

Type	PCB mount - Male header
Mounting Type	Wave - through hole
Orientation	Horizontal
Join	Solid body non stackable
Pitch (mm)	7.62
Open/Closed/Screw/Flange	Screw Flange
Number of Poles	10
Max Current (A)	16A(UL) 15A(VDE)
Max Voltage (V)	300V(UL) 450V(VDE)
Height (mm)	8.6
Standard Colour	Green
Width (mm)	12
Length (mm)	86.48
Solder Pin Length (mm)	4
PCB Hole Diameter (mm)	1.6-1.7
Body Material	PA66 V0
Comments	Pole sizes / no of ways not shown, please contact us for availability
Min Temperature Rating °C	-40
Max Temperature Rating °C	105

INDUSTRY ACCREDITATIONS

