

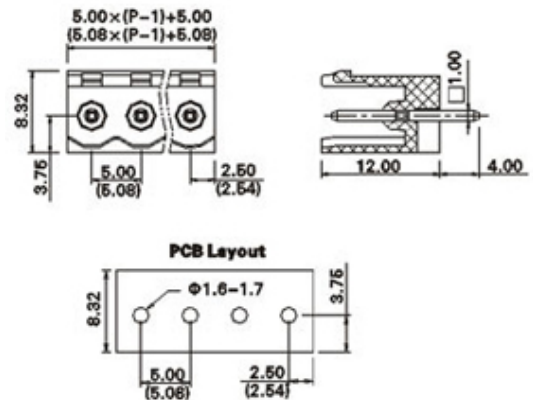

Pluggable Pin Header (Male) - Single Row PCB Header

Range: PCB Terminal Blocks, Connectors and Fuse Holders

Part Number: TLPH-200V-08P5



DESCRIPTION

8 Pole Vertical PCB terminal block 10mm pitch 12A 300V

Subject to technical modification without notice.

Typographical and other errors do not justify claim for damages.

SPECIFICATION

Type	PCB mount - Male header
Mounting Type	Wave - through hole
Orientation	Vertical
Join	Solid body non stackable
Pitch (mm)	10
Open/Closed/Screw/Flange	Open End
Number of Poles	8
Max Current (A)	12
Max Voltage (V)	300
Height (mm)	12
Standard Colour	Green
Width (mm)	8.32
Length (mm)	75
Solder Pin Length (mm)	4
PCB Hole Diameter (mm)	1.6 - 1.7
Body Material	PA66 V0
Comments	Pole sizes / no of ways not shown, please contact us for availability
Max Temperature Rating °C	105
Max Wire Size AWG	-40

INDUSTRY ACCREDITATIONS

