

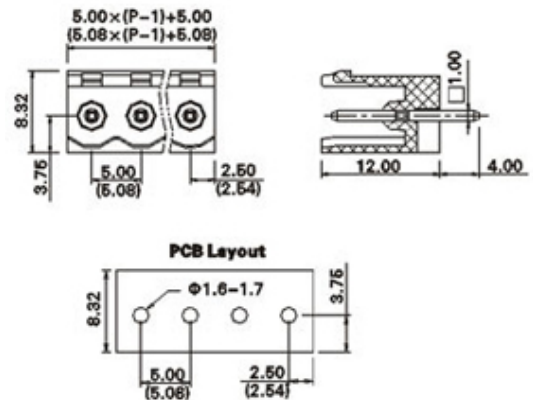

Pluggable Pin Header (Male) - Single Row PCB Header

Range: PCB Terminal Blocks, Connectors and Fuse Holders

Part Number: TLPH-200V-24P



DESCRIPTION

24 Pole Vertical PCB terminal block 5mm pitch 12A 300V

Subject to technical modification without notice.

Typographical and other errors do not justify claim for damages.

SPECIFICATION

Type	PCB mount - Male header
Mounting Type	Wave - through hole
Orientation	Vertical
Join	Solid body non stackable
Pitch (mm)	5
Open/Closed/Screw/Flange	Open End
Number of Poles	24
Max Current (A)	12
Max Voltage (V)	300
Height (mm)	8.45
Standard Colour	Green
Width (mm)	12
Length (mm)	65
Solder Pin Length (mm)	4
PCB Hole Diameter (mm)	1.6-1.7
Comments	Pole sizes / no of ways not shown, please contact us for availability
Max Temperature Rating °C	105
Max Wire Size AWG	-40

INDUSTRY ACCREDITATIONS

