

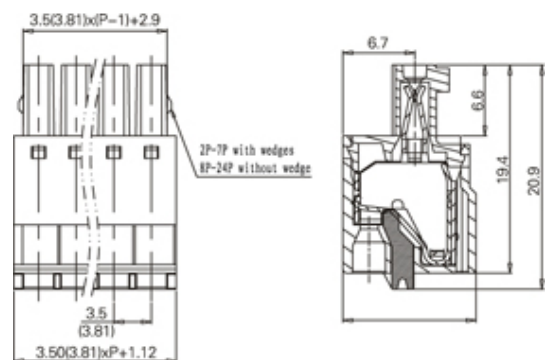

Pluggable Cable Mounting - Pluggable (Female)

Range: PCB Terminal Blocks, Connectors and Fuse Holders

Order Code: TLPS-101V-21P



DESCRIPTION

21 Pole Pluggable type Horizontal 3.81mm pitch 12A(UL)A 300V(UL)V

Subject to technical modification without notice.

Typographical and other errors do not justify claim for damages.

SPECIFICATION

Connection Method	Pluggable type
Mounting Type	Horizontal
Orientation	Horizontal
Join	Solid body non stackable
Pitch (mm)	3.81
Number of Poles	21
Max Current (A)	12A(UL)
Max Voltage (V)	300V(UL)
Height (mm)	20.9
Standard Colour	Green
Width (mm)	12.4
Length (mm)	79.1
Body Material	PA66 V0