

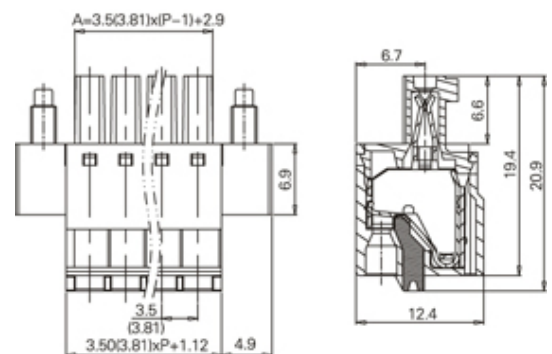

# Pluggable Cable Mounting - Pluggable (Female)

Range: PCB Terminal Blocks, Connectors and Fuse Holders

Order Code: TLPSW-101V-22P



## DESCRIPTION

22 Pole Pluggable type Horizontal 3.81mm pitch 12A(UL) 300V(UL)

*Subject to technical modification without notice.*

*Typographical and other errors do not justify claim for damages.*

## SPECIFICATION

<b>Connection Method</b>	Pluggable type
<b>Mounting Type</b>	Horizontal
<b>Orientation</b>	Horizontal
<b>Join</b>	Solid body non stackable
<b>Pitch (mm)</b>	3.81
<b>Number of Poles</b>	22
<b>Max Current (A)</b>	12A(UL)
<b>Max Voltage (V)</b>	300V(UL)
<b>Height (mm)</b>	20.9
<b>Width (mm)</b>	12.4
<b>Length (mm)</b>	94.74
<b>Body Material</b>	PA66 V0