

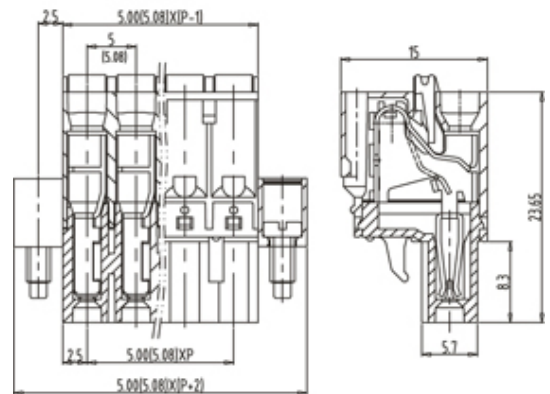

Pluggable Cable Mounting - Pluggable (Female)

Range: PCB Terminal Blocks, Connectors and Fuse Holders

Order Code: TLPSW-201V-13P

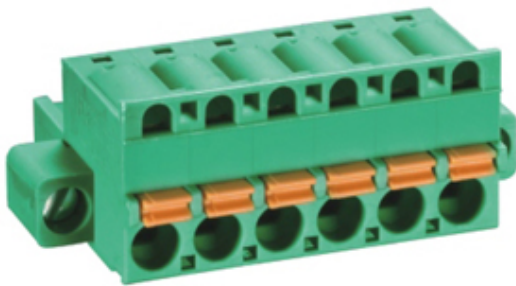

DESCRIPTION

13 Pole Pluggable type Horizontal 5mm pitch 12A(UL) 300V(UL)

Subject to technical modification without notice.

Typographical and other errors do not justify claim for damages.

SPECIFICATION

| | |
|--------------------------|--------------------------|
| Connection Method | Pluggable type |
| Mounting Type | Horizontal |
| Orientation | Horizontal |
| Join | Solid body non stackable |
| Pitch (mm) | 5 |
| Number of Poles | 13 |
| Max Current (A) | 12A(UL) |
| Max Voltage (V) | 300V(UL) |
| Height (mm) | 23.65 |
| Width (mm) | 15 |
| Length (mm) | 75 |
| Body Material | PA66 V0 |