

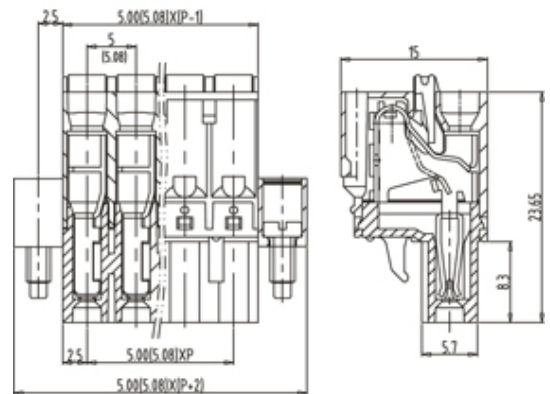

# Pluggable Cable Mounting - Pluggable (Female)

Range: PCB Terminal Blocks, Connectors and Fuse Holders

Order Code: TLPSW-302V-10P

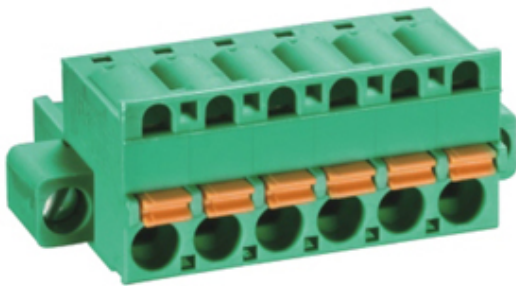

## DESCRIPTION

10 Pole Pluggable type Horizontal 5.08mm pitch 12A(UL) 300V(UL)

*Subject to technical modification without notice.*

*Typographical and other errors do not justify claim for damages.*

## SPECIFICATION

<b>Connection Method</b>	Pluggable type
<b>Mounting Type</b>	Horizontal
<b>Orientation</b>	Horizontal
<b>Join</b>	Solid body non stackable
<b>Pitch (mm)</b>	5.08
<b>Number of Poles</b>	10
<b>Max Current (A)</b>	12A(UL)
<b>Max Voltage (V)</b>	300V(UL)
<b>Height (mm)</b>	23.65
<b>Width (mm)</b>	15
<b>Length (mm)</b>	60.96
<b>Body Material</b>	PA66 V0