



Pluggable Cable Mounting - Pluggable (Female)

Range: PCB Terminal Blocks, Connectors and Fuse Holders

Part Number: TLPSD-007V-09P



Product Image
Not Available

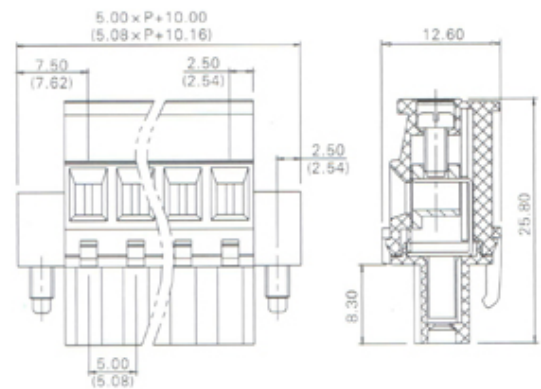

DESCRIPTION

9 Pole Pluggable type Horizontal 3.5mm pitch 8A 150V

Subject to technical modification without notice.

Typographical and other errors do not justify claim for damages.

SPECIFICATION

Connection Method	Pluggable type
Mounting Type	Horizontal
Orientation	Horizontal
Join	Solid body non stackable
Pitch (mm)	3.5
Number of Poles	9
Max Current (A)	8
Max Voltage (V)	150
Height (mm)	22.9
Width (mm)	16
Length (mm)	32.2
Body Material	PA66 V0