

Accessories

Range: Emech Terminals/Accessories

Order Code: HY500/5 cover

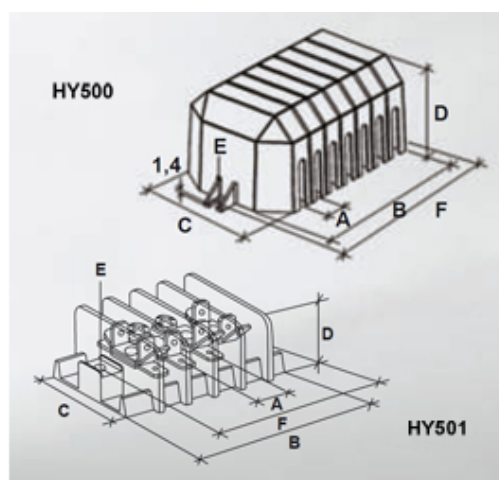

DESCRIPTION

5 pole grey polyamide cover 11mm pitch

Subject to technical modification without notice.

Typographical and other errors do not justify claim for damages.

SPECIFICATION

Number of Poles	5
Body Material	Polyamide
Colour	Grey
UL94 Rating	UL94V1
Glow Wire Resistance Test Temp	GWT750Å°C in 2 sec (EN60695-2-11)
Pitch (mm)	11
Height (mm)	45
Width (mm)	63
Length (mm)	78

INDUSTRY ACCREDITATIONS

