

Accessories

Range: Emech Terminals/Accessories

Order Code: HY500/12 cover

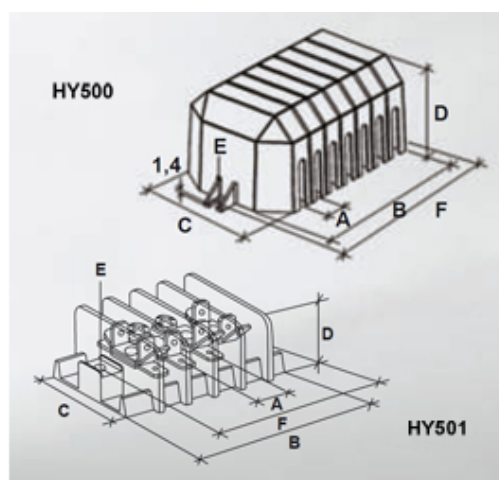

DESCRIPTION

12 pole grey polyamide cover 11mm pitch

Subject to technical modification without notice.

Typographical and other errors do not justify claim for damages.

SPECIFICATION

Number of Poles	12
Body Material	Polyamide
Colour	Grey
UL94 Rating	UL94V1
Glow Wire Resistance Test Temp	GWT750Å°C in 2 sec (EN60695-2-11)
Pitch (mm)	11
Height (mm)	45
Width (mm)	63
Length (mm)	155

INDUSTRY ACCREDITATIONS

