

Fused Pillar Terminal Blocks

Range: Emech Terminals/Accessories

Order Code: CFS-FNS-S10-S04 (HY133/4)

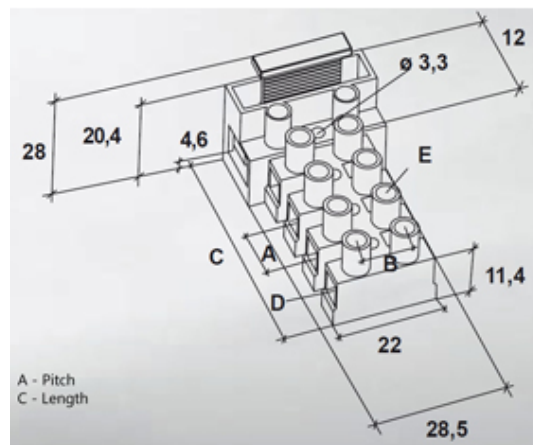

DESCRIPTION

4 pole grey polyamide PA6.8 fused pillar terminal block 10mm pitch 24a 450v

Subject to technical modification without notice.

Typographical and other errors do not justify claim for damages.

SPECIFICATION

Number of Poles	4
Terminal Material	OT58 nickel plated
Body Material	Polyamide PA6.8
Colour	Grey
Max Conductor Size (Sq mm)	2.5
Max Current (A)	24
Max Voltage (V)	450
Pitch (mm)	10
Height (mm)	28
Width (mm)	28.5
Length (mm)	41
Comments	Interlockable of on 1 side.
Terminal Screw Material	White zinc plated steel

INDUSTRY ACCREDITATIONS

