

Plugs and Sockets

Range: Emech Terminals/Accessories

Part Number: HY403/2 NYSPMLP



Product Image
Not Available

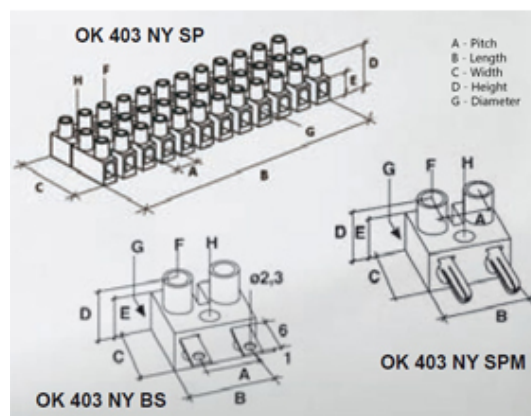

DESCRIPTION

2 pole natural polyamide PA6.6 wire protected plug for ok433 spf plug and socket terminal block 10mm pitch 24a 450v

Subject to technical modification without notice.

Typographical and other errors do not justify claim for damages.

SPECIFICATION

Number of Poles	2
Terminal Type	Wire Protected
Body Material	Polyamide PA6.6
Colour	Natural
UL94 Rating	UL94V2
Min Conductor Size (Sq mm)	2.5
Max Current (A)	24
Max Voltage (V)	450
Working Temperature	110
Pitch (mm)	10
Height (mm)	15.8
Width (mm)	14
Length (mm)	17.5
Diameter (mm)	3.5
Flammability Rating	UL94V2 and GWIT775°C
Comments	plug for OK433 SPF
Terminal Screw Material	White zinc plated steel
Wire Protection Material	Stainless Steel

INDUSTRY ACCREDITATIONS

