

# Plugs and Sockets

## Range: Emech Terminals/Accessories

Order Code: HY403/2 NYSPMLP



Product Image  
Not Available

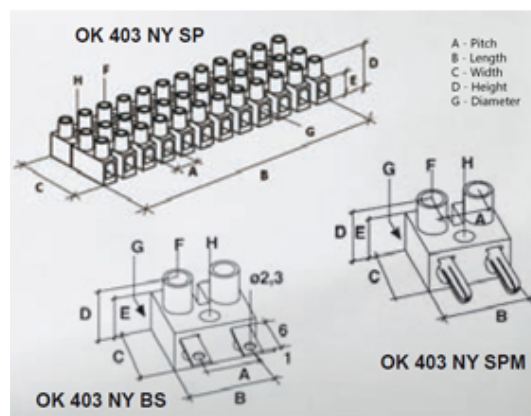

### DESCRIPTION

2 pole natural polyamide PA6.6 wire protected plug for ok433 spf plug and socket terminal block 10mm pitch 24a 450v

*Subject to technical modification without notice.*

*Typographical and other errors do not justify claim for damages.*

## SPECIFICATION

<b>Number of Poles</b>	2
<b>Terminal Type</b>	Wire Protected
<b>Body Material</b>	Polyamide PA6.6
<b>Colour</b>	Natural
<b>UL94 Rating</b>	UL94V2
<b>Min Conductor Size (Sq mm)</b>	2.5
<b>Max Current (A)</b>	24
<b>Max Voltage (V)</b>	450
<b>Working Temperature</b>	110
<b>Pitch (mm)</b>	10
<b>Height (mm)</b>	15.8
<b>Width (mm)</b>	14
<b>Length (mm)</b>	17.5
<b>Diameter (mm)</b>	3.5
<b>Flammability Rating</b>	UL94V2 and GWIT775Å°C
<b>Comments</b>	plug for OK433 SPF
<b>Terminal Screw Material</b>	White zinc plated steel
<b>Wire Protection Material</b>	Stainless Steel

## INDUSTRY ACCREDITATIONS

