

Screw to Pushwire Pillar Blocks

Range: Emech Terminals/Accessories

Order Code: HY200/6 FVSP

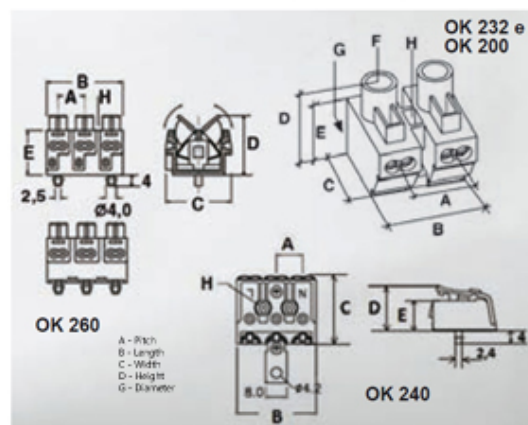
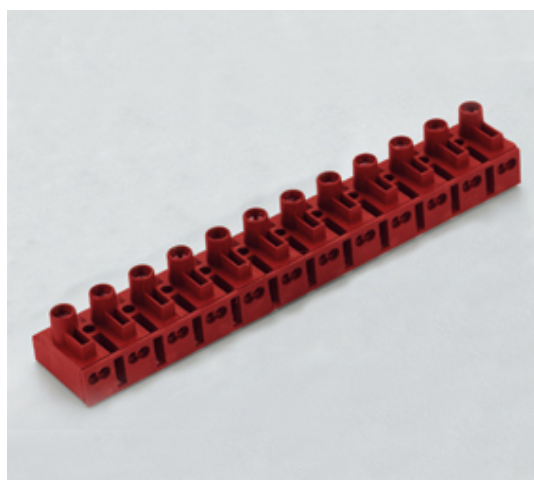

DESCRIPTION

6 pole polyamide PA6.6 screw to pushwire pillar block 10mm pitch 32a 450v

Subject to technical modification without notice.

Typographical and other errors do not justify claim for damages.

SPECIFICATION

Number of Poles	6
Terminal Material	Nickel plated steel
Body Material	Polyamide PA6.6
UL94 Rating	UL94V0
Max Conductor Size (Sq mm)	1.5/4
Max Current (A)	32
Max Voltage (V)	450
Working Temperature	150
Pitch (mm)	10
Height (mm)	16.2
Width (mm)	20.4
Length (mm)	57
Diameter (mm)	2.8
Comments	without foot
Terminal Screw Material	White zinc plated steel

INDUSTRY ACCREDITATIONS

