

Tab to Tab Terminal Blocks

Range: Emech Terminals/Accessories

Part Number: HY400/4 05BS

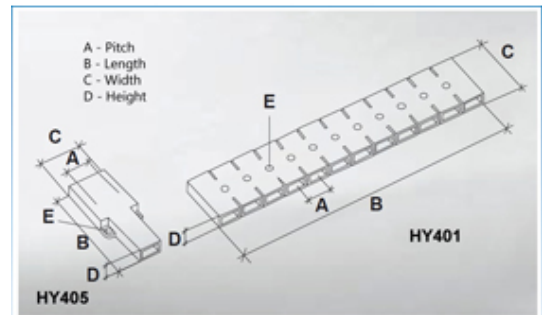

DESCRIPTION

4 pole transparent PVC with solderable pin tab to tab terminal block 8.3mm pitch

Subject to technical modification without notice.

Typographical and other errors do not justify claim for damages.

SPECIFICATION

Number of Poles	4
Tab Size (mm)	2.8x0.5
Terminal Material	Copper and nickel plated steel
Body Material	PVC
Colour	Transparent
UL94 Rating	UL94V0
Pitch (mm)	8.3
Height (mm)	6
Width (mm)	20
Length (mm)	34.6
Comments	With solderable Pin

INDUSTRY ACCREDITATIONS

