

Tab to Tab Terminal Blocks

Range: Emech Terminals/Accessories

Part Number: HY400/5 08

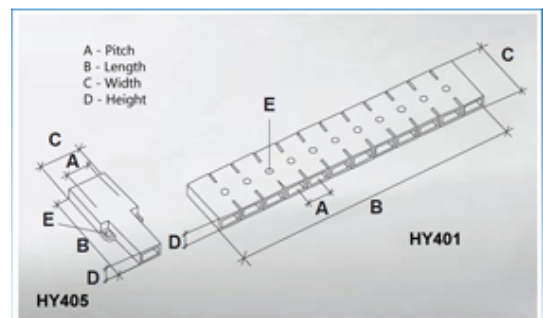
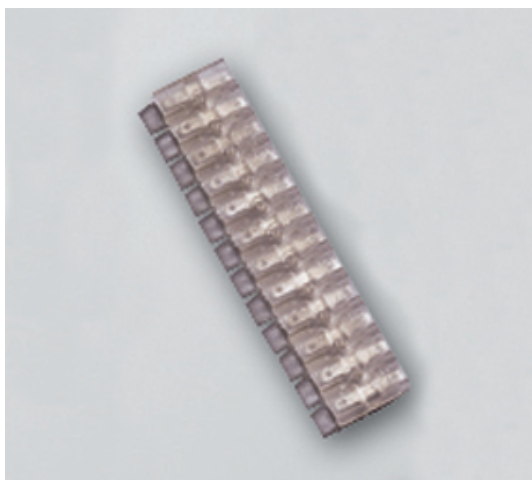

DESCRIPTION

5 pole transparent PVC tab to tab terminal block 8.3mm pitch

Subject to technical modification without notice.

Typographical and other errors do not justify claim for damages.

SPECIFICATION

Number of Poles	5
Tab Size (mm)	2.8x0.8
Terminal Material	Copper and nickel plated steel
Body Material	PVC
Colour	Transparent
UL94 Rating	UL94V0
Pitch (mm)	8.3
Height (mm)	6
Width (mm)	20
Length (mm)	42.9

INDUSTRY ACCREDITATIONS

