

# Tab to Tab Terminal Blocks

## Range: Emech Terminals/Accessories

Order Code: HY400/6 08BS

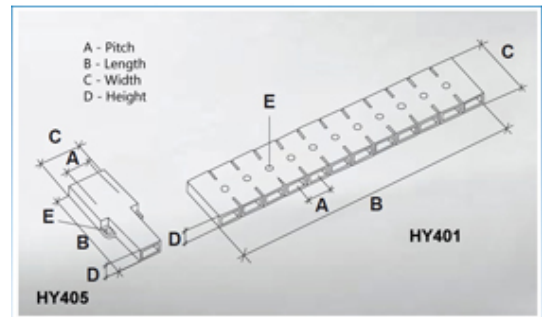

### DESCRIPTION

6 pole transparent PVC with solderable pin tab to tab terminal block 8.3mm pitch

*Subject to technical modification without notice.*

*Typographical and other errors do not justify claim for damages.*

## SPECIFICATION

Number of Poles	6
Tab Size (mm)	2.8x0.8
Terminal Material	Copper and nickel plated steel
Body Material	PVC
Colour	Transparent
UL94 Rating	UL94V0
Pitch (mm)	8.3
Height (mm)	6
Width (mm)	20
Length (mm)	51.2
Comments	With solderable Pin

## INDUSTRY ACCREDITATIONS

