

Tab to Tab Terminal Blocks

Range: Emech Terminals/Accessories

Order Code: HY400/10 08

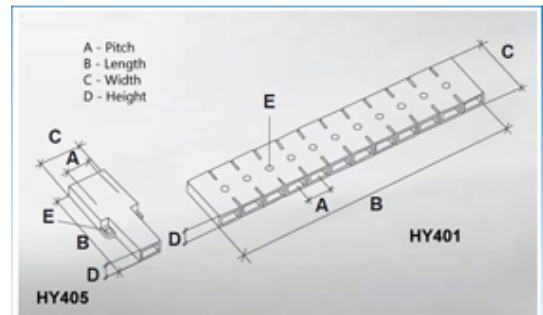

DESCRIPTION

10 pole transparent PVC tab to tab terminal block 8.3mm pitch

Subject to technical modification without notice.

Typographical and other errors do not justify claim for damages.

SPECIFICATION

Number of Poles	10
Tab Size (mm)	2.8x0.8
Terminal Material	Copper and nickel plated steel
Body Material	PVC
Colour	Transparent
UL94 Rating	UL94V0
Pitch (mm)	8.3
Height (mm)	6
Width (mm)	20
Length (mm)	84.4

INDUSTRY ACCREDITATIONS

