

Tab to Tab Terminal Blocks

Range: Emech Terminals/Accessories

Order Code: HY401/2

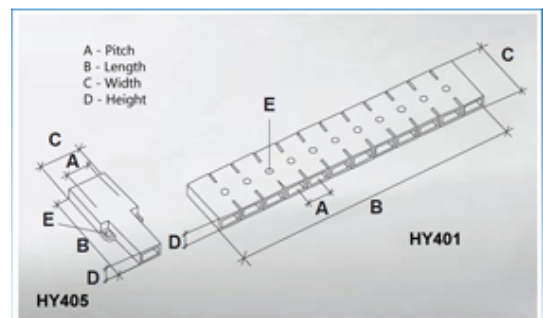

DESCRIPTION

2 pole transparent Nylon tab to tab terminal block 12.5mm pitch

Subject to technical modification without notice.

Typographical and other errors do not justify claim for damages.

SPECIFICATION

Number of Poles	2
Tab Size (mm)	6.35x0.8
Terminal Material	Copper and nickel plated steel
Body Material	Nylon
Colour	Transparent
UL94 Rating	UL94V0
Max Conductor Size (Sq mm)	2.5
Max Current (A)	24
Max Voltage (V)	450
Pitch (mm)	12.5
Height (mm)	7.5
Width (mm)	29
Length (mm)	24

INDUSTRY ACCREDITATIONS

