

# Tab to Tab Terminal Blocks

## Range: Emech Terminals/Accessories

Order Code: HY401/2 L

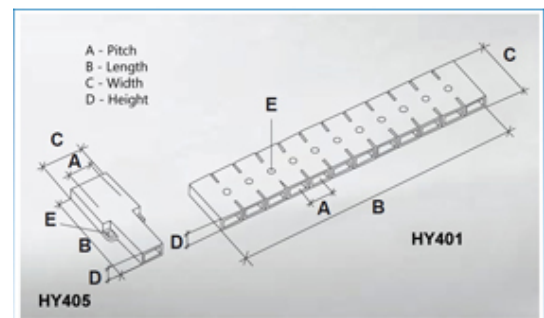
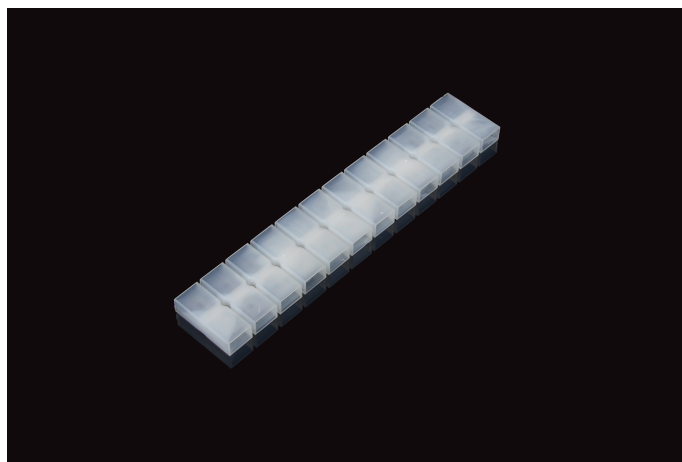

### DESCRIPTION

2 pole transparent Nylon tab to tab terminal block 23mm pitch

*Subject to technical modification without notice.*

*Typographical and other errors do not justify claim for damages.*

## SPECIFICATION

Number of Poles	2
Tab Size (mm)	6.35x0.8
Terminal Material	Copper and nickel plated steel
Body Material	Nylon
Colour	Transparent
UL94 Rating	UL94V0
Pitch (mm)	23
Height (mm)	7.5
Width (mm)	50
Length (mm)	-93

## INDUSTRY ACCREDITATIONS

