

Tab to Tab Terminal Blocks

Range: Emech Terminals/Accessories

Part Number: HY401/5 L

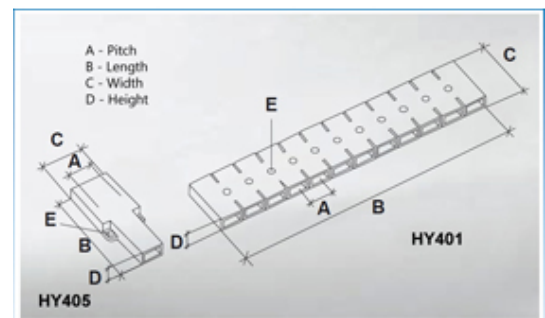
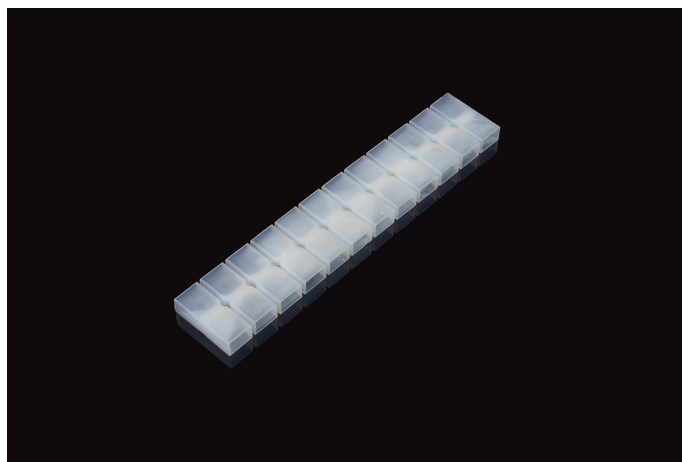

DESCRIPTION

5 pole transparent Nylon tab to tab terminal block 23mm pitch

Subject to technical modification without notice.

Typographical and other errors do not justify claim for damages.

SPECIFICATION

Number of Poles	5
Tab Size (mm)	6.35x0.8
Terminal Material	Copper and nickel plated steel
Body Material	Nylon
Colour	Transparent
UL94 Rating	UL94V0
Pitch (mm)	23
Height (mm)	7.5
Width (mm)	50
Length (mm)	-24

INDUSTRY ACCREDITATIONS

