

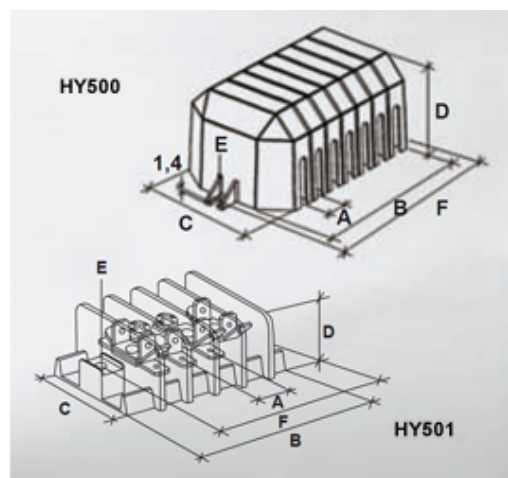

# Tab to Tab Terminal Blocks

## Range: Emech Terminals/Accessories

Order Code: CTB-TMS-STD-N04 (HY501/4 E)

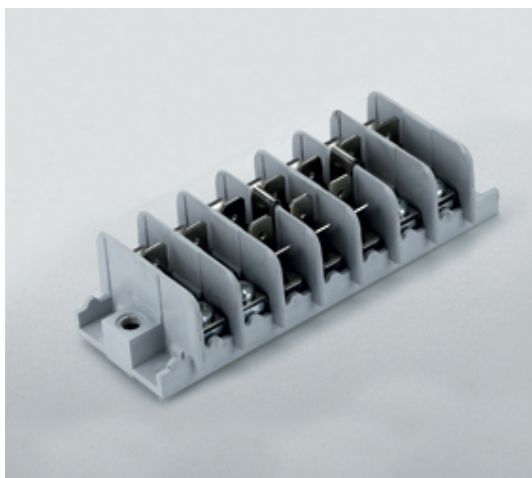

### DESCRIPTION

4 pole grey polyamide tailor made tab terminal block 11mm pitch 24a 450v

*Subject to technical modification without notice.*

*Typographical and other errors do not justify claim for damages.*

## SPECIFICATION

Number of Poles	4
Tabs Per Pole	11
Tab Size (mm)	6.3x0.8
Terminal Material	White zinc plated high resistance steel
Body Material	Polyamide
Colour	Grey
UL94 Rating	UL94V1
Glow Wire Resistance Test Temp	GWT750Å°C in 2 sec (EN60695-2-11)
Max Conductor Size (Sq mm)	2.5
Max Current (A)	24
Max Voltage (V)	450
Working Temperature	105
Pitch (mm)	11
Height (mm)	23.2
Width (mm)	36.7
Length (mm)	63.4
Diameter (mm)	4.2

## INDUSTRY ACCREDITATIONS



## ADDITIONAL INFORMATION

### Elementi di connessione per HY 501:

#### Connection elements for HY 501:

A	ECM bipolare faston/faston - bipolar tab/tab	0°
B	ECM bipolare faston/faston - bipolar tab/tab	45°
C	ECM bipolare faston/faston - bipolar tab/tab	90°
D	ECM unipolare faston - unipolar tab	0°
E	ECM unipolare faston - unipolar tab	45°
F	ECM unipolare faston - unipolar tab	90°
G	ECM bipolare viteM4/faston - bipolar screwM4/tab	0°
H	ECM bipolare viteM4/faston - bipolar screwM4/tab	45°
I	ECM bipolare viteM4/faston - bipolar screwM4/tab	90°
L	ECM bipolare viteM4/vite - bipolar screwM4/screw	
M	ECM bipolare faston/faston - bipolar tab/tab	45°/90°

