

# Tab to Tab Terminal Blocks

## Range: Emech Terminals/Accessories

Order Code: CTB-TMB-STD-N06 (HY501/6)

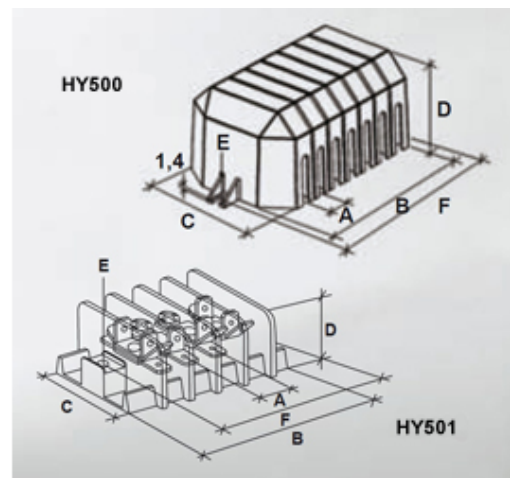
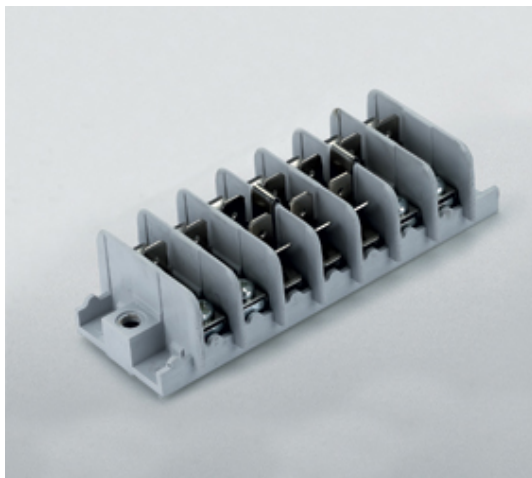

### DESCRIPTION

6 pole grey polyamide tailor made tab terminal block 11mm pitch 24a 450v

*Subject to technical modification without notice.*

*Typographical and other errors do not justify claim for damages.*

## SPECIFICATION

|                                |                                   |
|--------------------------------|-----------------------------------|
| Number of Poles                | 6                                 |
| Tabs Per Pole                  | 11                                |
| Tab Size (mm)                  | 6.3x0.8                           |
| Terminal Material              | OT67 nickel plated                |
| Body Material                  | Polyamide                         |
| Colour                         | Grey                              |
| UL94 Rating                    | UL94V1                            |
| Glow Wire Resistance Test Temp | GWT750Å°C in 2 sec (EN60695-2-11) |
| Max Conductor Size (Sq mm)     | 2.5                               |
| Max Current (A)                | 24                                |
| Max Voltage (V)                | 450                               |
| Working Temperature            | 105                               |
| Pitch (mm)                     | 11                                |
| Height (mm)                    | 23.2                              |
| Width (mm)                     | 36.7                              |
| Length (mm)                    | 85.4                              |
| Diameter (mm)                  | 4.2                               |

## INDUSTRY ACCREDITATIONS



## ADDITIONAL INFORMATION

### Elementi di connessione per HY 501:

#### Connection elements for HY 501:

|   |  |         |
|---|--|---------|
| A | ECM bipolare faston/faston - bipolar tab/tab     | 0°      |
| B | ECM bipolare faston/faston - bipolar tab/tab     | 45°     |
| C | ECM bipolare faston/faston - bipolar tab/tab     | 90°     |
| D | ECM unipolare faston - unipolar tab              | 0°      |
| E | ECM unipolare faston - unipolar tab              | 45°     |
| F | ECM unipolare faston - unipolar tab              | 90°     |
| G | ECM bipolare viteM4/faston - bipolar screwM4/tab | 0°      |
| H | ECM bipolare viteM4/faston - bipolar screwM4/tab | 45°     |
| I | ECM bipolare viteM4/faston - bipolar screwM4/tab | 90°     |
| L | ECM bipolare viteM4/vite - bipolar screwM4/screw |         |
| M | ECM bipolare faston/faston - bipolar tab/tab     | 45°/90° |

