

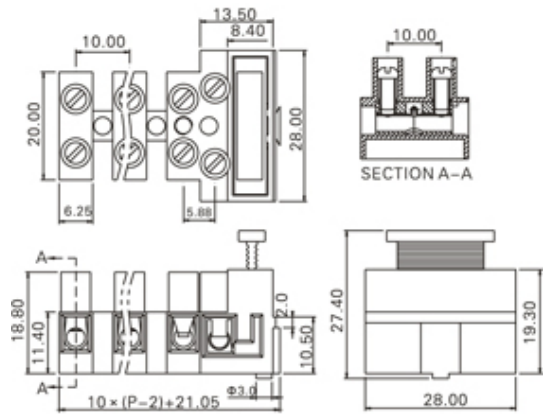

Fused PCB Terminal Block

Range: PCB Terminal Blocks, Connectors and Fuse Holders

Order Code: TLF-100E-2P



DESCRIPTION

2 Pole Fuse terminal Vertical mm pitch 20A(UL) 24A(VDE) 300V(UL) 450V(VDE)

Subject to technical modification without notice.

Typographical and other errors do not justify claim for damages.

SPECIFICATION

Connection Method	Fuse terminal
Mounting Type	Vertical
Orientation	Vertical
Join	Solid body non stackable
Number of Poles	2
Max Current (A)	20A(UL) 24A(VDE)
Max Voltage (V)	300V(UL) 450V(VDE)
Height (mm)	27.4
Standard Colour	Gray
Width (mm)	28
Length (mm)	21.05