

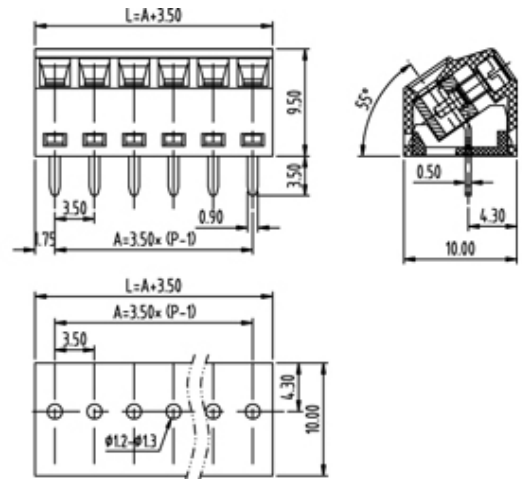

Rising Clamp - Single Row

Range: PCB Terminal Blocks, Connectors and Fuse Holders

Part Number: TL009-06PKS



DESCRIPTION

6 Pole Screw Rising Clamp 55 degree 55 degree 3.5mm pitch 10A(UL) 300V(VDE)

Subject to technical modification without notice.

Typographical and other errors do not justify claim for damages.

SPECIFICATION

Type	Screw
Connection Method	Rising Clamp
Mounting Type	55 degree
Orientation	55 degree
Join	Solid body non stackable
Pitch (mm)	3.5
Number of Poles	6
Max Current (A)	10A(UL)
Max Voltage (V)	300V(VDE)
Height (mm)	9.5
Standard Colour	Black
Width (mm)	10
Length (mm)	21
Solder Pin Length (mm)	3.5
PCB Hole Diameter (mm)	1.2-1.3
Body Material	PA66 V0