

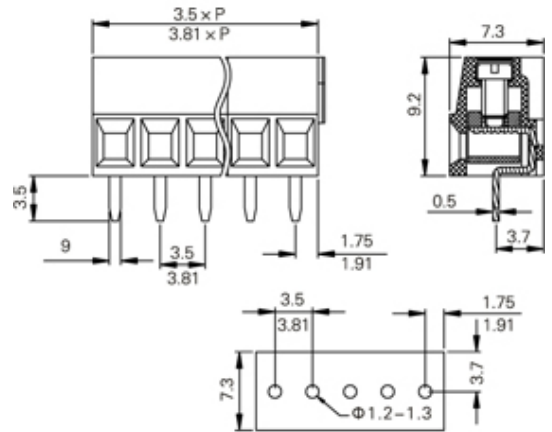

# Rising Clamp - Single Row

Range: PCB Terminal Blocks, Connectors and Fuse Holders

Part Number: TL104V-04PGS



## DESCRIPTION

4 Pole Screw Rising Clamp Vertical 3.81mm pitch 10A(UL) 300V(UL)

*Subject to technical modification without notice.*

*Typographical and other errors do not justify claim for damages.*

## SPECIFICATION

<b>Type</b>	Screw
<b>Connection Method</b>	Rising Clamp
<b>Mounting Type</b>	Vertical
<b>Orientation</b>	Vertical
<b>Join</b>	Interlocking
<b>Pitch (mm)</b>	3.81
<b>Number of Poles</b>	4
<b>Max Current (A)</b>	10A(UL)
<b>Max Voltage (V)</b>	300V(UL)
<b>Height (mm)</b>	9.2
<b>Standard Colour</b>	Green
<b>Width (mm)</b>	7.3
<b>Length (mm)</b>	15.24
<b>Solder Pin Length (mm)</b>	3.5
<b>PCB Hole Diameter (mm)</b>	1.2-1.3
<b>Body Material</b>	PA66 V0