

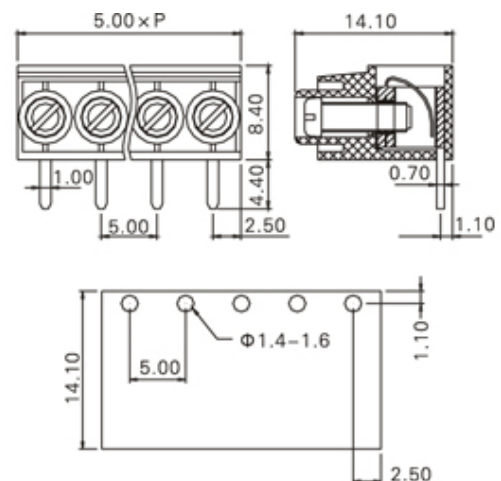

Through Hole Mount/Wire Protected

Range: PCB Terminal Blocks, Connectors and Fuse Holders

Order Code: TL209R-21PBS

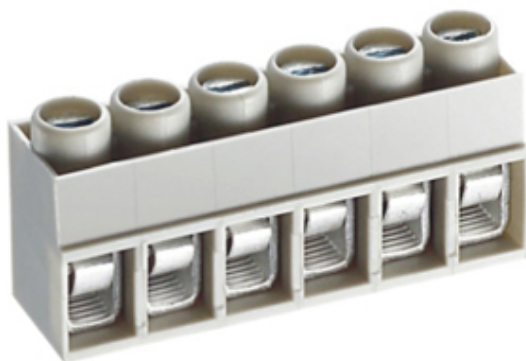

DESCRIPTION

21 Pole Screw Wire Protector Wave - through hole Horizontal 5mm pitch 15A 250V

Subject to technical modification without notice.

Typographical and other errors do not justify claim for damages.

SPECIFICATION

Type	Screw
Connection Method	Wire Protector
Mounting Type	Wave - through hole
Orientation	Horizontal
Join	Solid body non stackable
Pitch (mm)	5
Number of Poles	21
Min Wire Size (Sq mm)	0.33
Max Wire Size (Sq mm)	4
Max Current (A)	15
Max Voltage (V)	250
Height (mm)	8.4
Standard Colour	Beige
Width (mm)	14.1
Length (mm)	105
Solder Pin Length (mm)	4.4
PCB Hole Diameter (mm)	1.4-1.6
Body Material	PA66 V0
Comments	Pole sizes / no of ways not shown, please contact us for availability
Min Wire Size AWG	22
Max Wire Size AWG	12
Terminal Type	Wire protected