

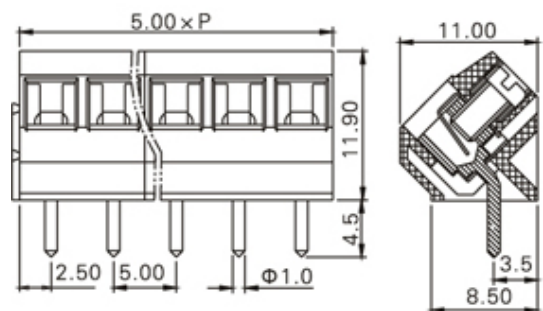

Through Hole Mount/Wire Protected

Range: PCB Terminal Blocks, Connectors and Fuse Holders

Order Code: TL210-13P



DESCRIPTION

13 Pole Screw Wire Protector Wave - through hole Vertical 5mm pitch 15A 300V

Subject to technical modification without notice.

Typographical and other errors do not justify claim for damages.

SPECIFICATION

| | |
|---------------------------|---|
| Type | Screw |
| Connection Method | Wire Protector |
| Mounting Type | Wave - through hole |
| Orientation | Vertical |
| Join | Interlocking |
| Pitch (mm) | 5 |
| Number of Poles | 13 |
| Min Wire Size (Sq mm) | 0.33 |
| Max Wire Size (Sq mm) | 1.75 |
| Max Current (A) | 15 |
| Max Voltage (V) | 300 |
| Height (mm) | 11.9 |
| Standard Colour | Black |
| Width (mm) | 11 |
| Length (mm) | 65 |
| Solder Pin Length (mm) | 4.5 |
| PCB Hole Diameter (mm) | 1.2-1.4 |
| Comments | Pole sizes / no of ways not shown, please contact us for availability |
| Min Temperature Rating °C | -30 |
| Max Temperature Rating °C | 105 |
| Min Wire Size AWG | 22 |
| Max Wire Size AWG | 14 |
| Terminal Type | Wire protected |

INDUSTRY ACCREDITATIONS

