

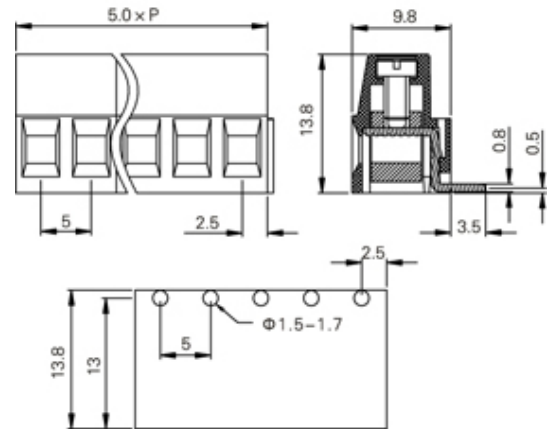

Rising Clamp - Single Row

Range: PCB Terminal Blocks, Connectors and Fuse Holders

Part Number: TL214R-07PGS

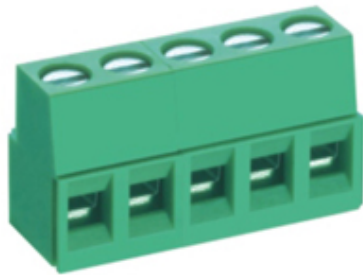

DESCRIPTION

7 Pole Screw Rising Clamp Horizontal 5mm pitch 20A(UL) 300V(UL)

*Subject to technical modification without notice.
Typographical and other errors do not justify claim for damages.*

SPECIFICATION

Type	Screw
Connection Method	Rising Clamp
Mounting Type	Horizontal
Orientation	Horizontal
Join	Interlocking
Pitch (mm)	5
Number of Poles	7
Max Current (A)	20A(UL)
Max Voltage (V)	300V(UL)
Height (mm)	13.8
Standard Colour	Green
Width (mm)	9.8
Length (mm)	35
Solder Pin Length (mm)	3.5
PCB Hole Diameter (mm)	1.5-1.7
Body Material	PA66 V0