

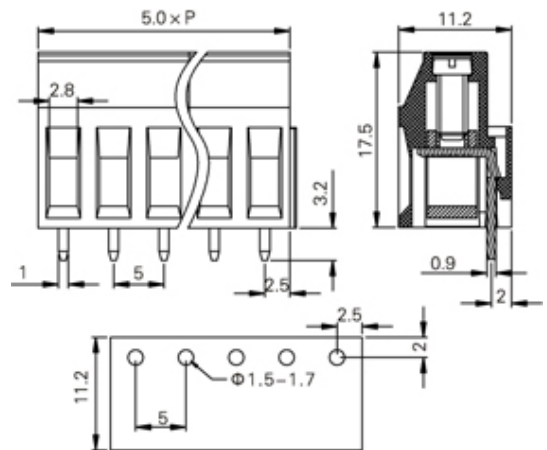

Rising Clamp - Single Row

Range: PCB Terminal Blocks, Connectors and Fuse Holders

Order Code: TL217V01-14PGS



DESCRIPTION

14 Pole Screw Rising Clamp Vertical 5mm pitch 20A(UL) 300V(UL)

*Subject to technical modification without notice.
Typographical and other errors do not justify claim for damages.*

SPECIFICATION

Type	Screw
Connection Method	Rising Clamp
Mounting Type	Vertical
Orientation	Vertical
Join	Interlocking
Pitch (mm)	5
Number of Poles	14
Max Current (A)	20A(UL)
Max Voltage (V)	300V(UL)
Height (mm)	17.5
Standard Colour	Green
Width (mm)	11.2
Length (mm)	70
Solder Pin Length (mm)	3.2
PCB Hole Diameter (mm)	1.5-1.7
Body Material	PA66 V0