

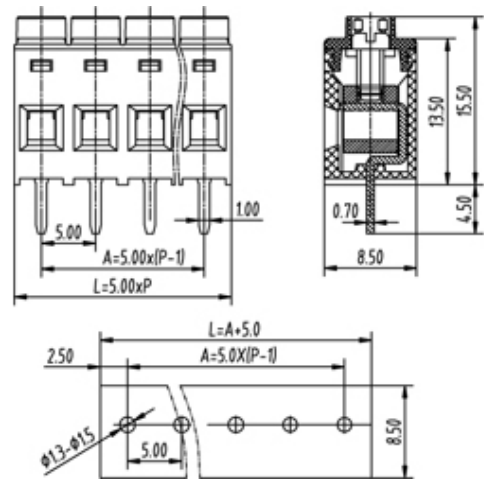

Rising Clamp - Single Row

Range: PCB Terminal Blocks, Connectors and Fuse Holders

Order Code: TL225V-24PGS



DESCRIPTION

24 Pole Screw Rising Clamp Vertical 5mm pitch 16A(UL) 300V(UL)

Subject to technical modification without notice.

Typographical and other errors do not justify claim for damages.

SPECIFICATION

Type	Screw
Connection Method	Rising Clamp
Mounting Type	Vertical
Orientation	Vertical
Join	Solid body non stackable
Pitch (mm)	5
Number of Poles	24
Max Current (A)	16A(UL)
Max Voltage (V)	300V(UL)
Height (mm)	15.5
Standard Colour	Green
Width (mm)	8.5
Length (mm)	120
Solder Pin Length (mm)	4.5
PCB Hole Diameter (mm)	1.3-1.5
Body Material	PA66 V0