

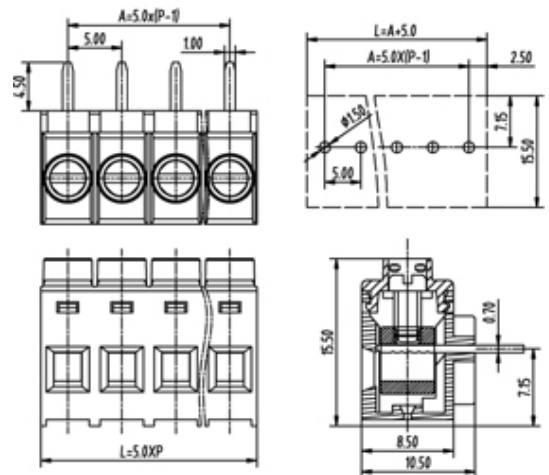

# Rising Clamp - Single Row

Range: PCB Terminal Blocks, Connectors and Fuse Holders

Part Number: TL225R-04PGS



## DESCRIPTION

4 Pole Screw Rising Clamp Horizontal 5mm pitch 16A(UL) 300V(UL)

*Subject to technical modification without notice.*

*Typographical and other errors do not justify claim for damages.*

## SPECIFICATION

<b>Type</b>	Screw
<b>Connection Method</b>	Rising Clamp
<b>Mounting Type</b>	Horizontal
<b>Orientation</b>	Horizontal
<b>Join</b>	Solid body non stackable
<b>Pitch (mm)</b>	5
<b>Number of Poles</b>	4
<b>Max Current (A)</b>	16A(UL)
<b>Max Voltage (V)</b>	300V(UL)
<b>Height (mm)</b>	15.5
<b>Standard Colour</b>	Green
<b>Width (mm)</b>	10.5
<b>Length (mm)</b>	20
<b>Solder Pin Length (mm)</b>	4.5
<b>PCB Hole Diameter (mm)</b>	1.5
<b>Body Material</b>	PA66 V0