

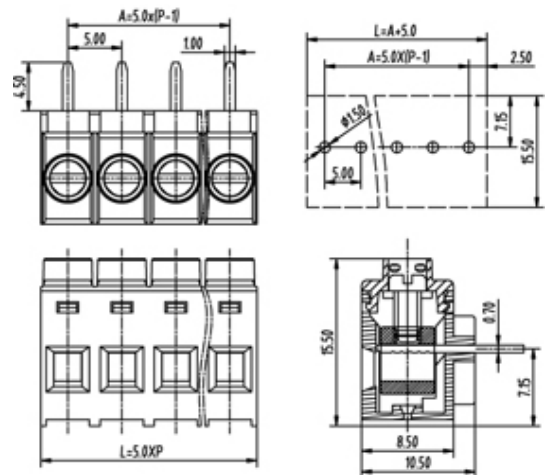

Rising Clamp - Single Row

Range: PCB Terminal Blocks, Connectors and Fuse Holders

Part Number: TL225R-07PGS



DESCRIPTION

7 Pole Screw Rising Clamp Horizontal 5mm pitch 16A(UL) 300V(UL)

Subject to technical modification without notice.

Typographical and other errors do not justify claim for damages.

SPECIFICATION

Type	Screw
Connection Method	Rising Clamp
Mounting Type	Horizontal
Orientation	Horizontal
Join	Solid body non stackable
Pitch (mm)	5
Number of Poles	7
Max Current (A)	16A(UL)
Max Voltage (V)	300V(UL)
Height (mm)	15.5
Standard Colour	Green
Width (mm)	10.5
Length (mm)	35
Solder Pin Length (mm)	4.5
PCB Hole Diameter (mm)	1.5
Body Material	PA66 V0