

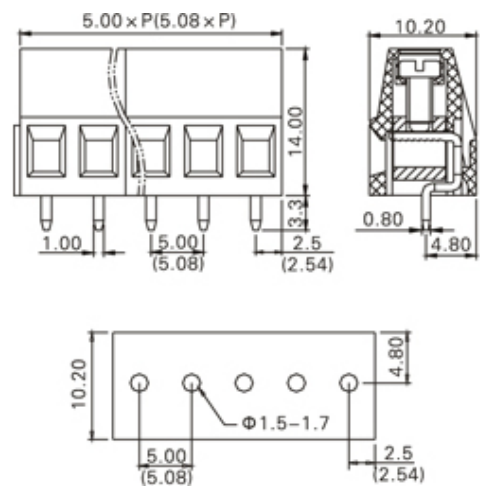

Rising Clamp - Single Row

Range: PCB Terminal Blocks, Connectors and Fuse Holders

Order Code: TL306V-22PGS



DESCRIPTION

22 Pole Screw Rising Clamp Wave - through hole Vertical 5.08mm pitch 12A 250V

Subject to technical modification without notice.

Typographical and other errors do not justify claim for damages.

SPECIFICATION

Type	Screw
Connection Method	Rising Clamp
Mounting Type	Wave - through hole
Orientation	Vertical
Join	Interlocking
Pitch (mm)	5.08
Number of Poles	22
Min Wire Size (Sq mm)	0.25
Max Wire Size (Sq mm)	2.5
Max Current (A)	12
Max Voltage (V)	250
Height (mm)	14.6
Standard Colour	Green
Width (mm)	10.2
Length (mm)	111.76
Solder Pin Length (mm)	3.3
PCB Hole Diameter (mm)	1.5-1.7
Body Material	PA66 V0
Comments	Pole sizes / no of ways not shown, please contact us for availability
Min Temperature Rating °C	-40
Max Temperature Rating °C	105
Min Wire Size AWG	24
Max Wire Size AWG	12

INDUSTRY ACCREDITATIONS

