

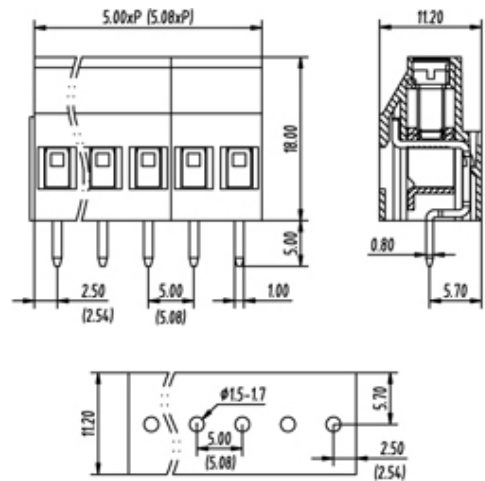

Rising Clamp - Single Row

Range: PCB Terminal Blocks, Connectors and Fuse Holders

Order Code: TL312V-05PGS

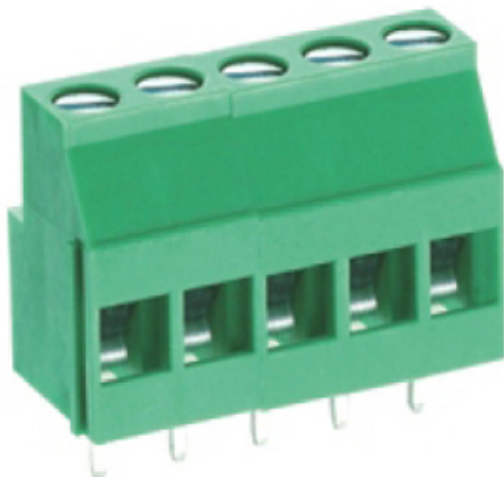

DESCRIPTION

5 Pole Screw Rising Clamp Wave - through hole Vertical 5.08mm pitch 20A 300V

Subject to technical modification without notice.

Typographical and other errors do not justify claim for damages.

SPECIFICATION

Type	Screw
Connection Method	Rising Clamp
Mounting Type	Wave - through hole
Orientation	Vertical
Join	Interlocking
Pitch (mm)	5.08
Number of Poles	5
Min Wire Size (Sq mm)	0.25
Max Wire Size (Sq mm)	4
Max Current (A)	20
Max Voltage (V)	300
Height (mm)	18
Standard Colour	Green
Width (mm)	11.2
Length (mm)	25.4
Solder Pin Length (mm)	5
PCB Hole Diameter (mm)	1.5-1.7
Body Material	PA66 V0
Comments	Pole sizes / no of ways not shown, please contact us for availability
Min Temperature Rating °C	-40
Max Temperature Rating °C	105
Min Wire Size AWG	24
Max Wire Size AWG	12

INDUSTRY ACCREDITATIONS

