

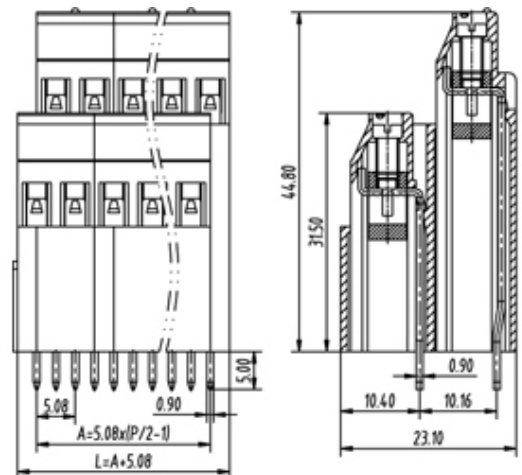

# Rising Clamp - Double Decker PCB

Range: PCB Terminal Blocks, Connectors and Fuse Holders

Order Code: CPT-RDA-5.08R-04BK (TL324VH2-04PKS)



## DESCRIPTION

4 Pole Screw Rising Clamp Vertical 5.08mm pitch 25A 300V

*Subject to technical modification without notice.*

*Typographical and other errors do not justify claim for damages.*

## SPECIFICATION

<b>Type</b>	Screw
<b>Connection Method</b>	Rising Clamp
<b>Mounting Type</b>	Vertical
<b>Orientation</b>	Vertical
<b>Join</b>	Interlocking
<b>Pitch (mm)</b>	5.08
<b>Number of Poles</b>	4
<b>Max Current (A)</b>	25
<b>Max Voltage (V)</b>	300
<b>Height (mm)</b>	44.8
<b>Standard Colour</b>	Black
<b>Width (mm)</b>	23.1
<b>Length (mm)</b>	10.16
<b>Solder Pin Length (mm)</b>	5
<b>PCB Hole Diameter (mm)</b>	1.4-1.5
<b>Body Material</b>	PA66 V0