

# Through Hole Mount/Wire Protected

Range: PCB Terminal Blocks, Connectors and Fuse Holders

Order Code: TL300V-08P5KC

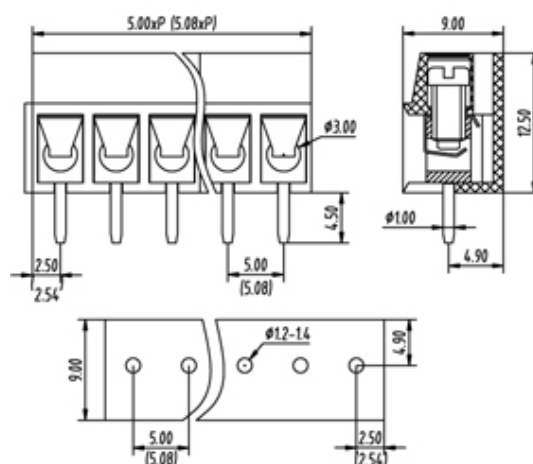

## DESCRIPTION

8 (IOI) Pole Screw Wire Protector Wave - through hole Vertical mm pitch 16A(UL) 24A(VDE) 300V(UL) 250V(VDE)

*Subject to technical modification without notice.*

*Typographical and other errors do not justify claim for damages.*

## SPECIFICATION

Type	Screw
Connection Method	Wire Protector
Mounting Type	Wave - through hole
Orientation	Vertical
Join	Interlocking
Pitch (mm)	10.16
Number of Poles	8
Min Wire Size (Sq mm)	0.33
Max Wire Size (Sq mm)	2.5
Max Current (A)	16A(UL) 24A(VDE)
Max Voltage (V)	300V(UL) 250V(VDE)
Height (mm)	12.5
Standard Colour	Black
Width (mm)	9
Length (mm)	76.16
Solder Pin Length (mm)	4.5
PCB Hole Diameter (mm)	1.2-1.4
Body Material	PA66 V0
Comments	Pole sizes / no of ways not shown, please contact us for availability
Min Temperature Rating °C	-40
Max Temperature Rating °C	105
Min Wire Size AWG	22
Max Wire Size AWG	14
Terminal Type	Wire protected

## INDUSTRY ACCREDITATIONS

