

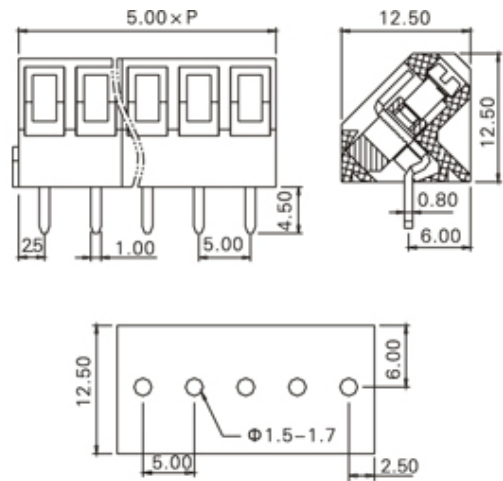

Rising Clamp - Single Row

Range: PCB Terminal Blocks, Connectors and Fuse Holders

Part Number: TL204-04PKS



DESCRIPTION

4 Pole Screw Rising Clamp Wave - through hole 45 degree 5mm pitch 16A(UL) 16A(VDE) 250V(UL) 130V(VDE)

Subject to technical modification without notice.

Typographical and other errors do not justify claim for damages.

SPECIFICATION

Type	Screw
Connection Method	Rising Clamp
Mounting Type	Wave - through hole
Orientation	45 degree
Join	Interlocking
Pitch (mm)	5
Number of Poles	4
Min Wire Size (Sq mm)	0.12
Max Wire Size (Sq mm)	2.5
Max Current (A)	16A(UL) 16A(VDE)
Max Voltage (V)	250V(UL) 130V(VDE)
Height (mm)	12.5
Standard Colour	Black
Width (mm)	12.5
Length (mm)	20
Solder Pin Length (mm)	4.5
PCB Hole Diameter (mm)	1.5-1.7
Body Material	PA66 V0
Comments	Pole sizes / no of ways not shown, please contact us for availability
Min Temperature Rating °C	-40
Max Temperature Rating °C	105
Min Wire Size AWG	26
Max Wire Size AWG	12

INDUSTRY ACCREDITATIONS

