

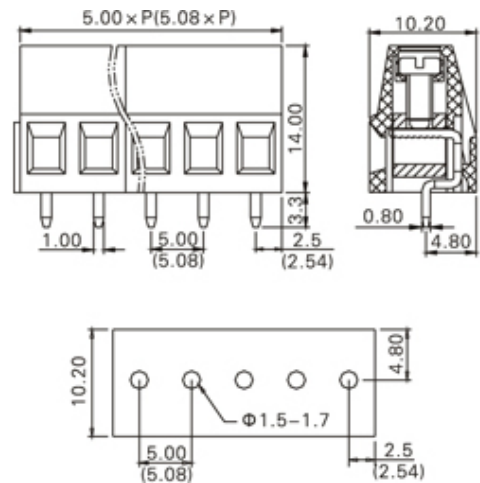

# Rising Clamp - Single Row

Range: PCB Terminal Blocks, Connectors and Fuse Holders

Part Number: TL206VT-04P5GS



## DESCRIPTION

4 (IOI) Pole Screw Rising Clamp Wave - through hole Vertical 10mm pitch 20A(UL) 12A(VDE) 300V(UL) 250V(VDE)

*Subject to technical modification without notice.*

*Typographical and other errors do not justify claim for damages.*

## SPECIFICATION

<b>Type</b>	Screw
<b>Connection Method</b>	Rising Clamp
<b>Mounting Type</b>	Wave - through hole
<b>Orientation</b>	Vertical
<b>Join</b>	Interlocking
<b>Pitch (mm)</b>	10
<b>Number of Poles</b>	4 (IOI)
<b>Min Wire Size (Sq mm)</b>	0.25
<b>Max Wire Size (Sq mm)</b>	2.5
<b>Max Current (A)</b>	20A(UL) 12A(VDE)
<b>Max Voltage (V)</b>	300V(UL) 250V(VDE)
<b>Height (mm)</b>	14.6
<b>Standard Colour</b>	Green
<b>Width (mm)</b>	10.2
<b>Length (mm)</b>	35
<b>Solder Pin Length (mm)</b>	3.3
<b>PCB Hole Diameter (mm)</b>	1.5-1.7
<b>Body Material</b>	PA66 V0
<b>Comments</b>	Pole sizes / no of ways not shown, please contact us for availability
<b>Min Temperature Rating °C</b>	-40
<b>Max Temperature Rating °C</b>	105
<b>Min Wire Size AWG</b>	24
<b>Max Wire Size AWG</b>	12

## INDUSTRY ACCREDITATIONS

