

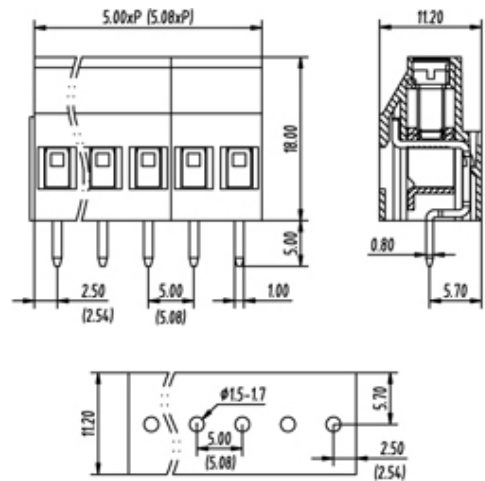

Rising Clamp - Single Row

Range: PCB Terminal Blocks, Connectors and Fuse Holders

Part Number: TL212V-12P5GS

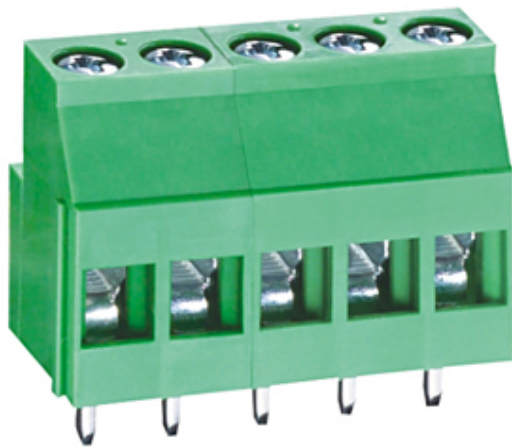

DESCRIPTION

12 (IOI) Pole Screw Rising Clamp Wave - through hole Vertical 10mm pitch 20(UL/VDE)A 300(UL/VDE)V

Subject to technical modification without notice.

Typographical and other errors do not justify claim for damages.

SPECIFICATION

Type	Screw
Connection Method	Rising Clamp
Mounting Type	Wave - through hole
Orientation	Vertical
Join	Interlocking
Pitch (mm)	10
Number of Poles	12
Min Wire Size (Sq mm)	0.25
Max Wire Size (Sq mm)	4
Max Current (A)	20(UL/VDE)
Max Voltage (V)	300(UL/VDE)
Height (mm)	18
Standard Colour	Green
Width (mm)	11.2
Length (mm)	115
Solder Pin Length (mm)	5
PCB Hole Diameter (mm)	1.5-1.7
Body Material	PA66 V0
Comments	Pole sizes / no of ways not shown, please contact us for availability
Min Wire Size AWG	24
Max Wire Size AWG	12