

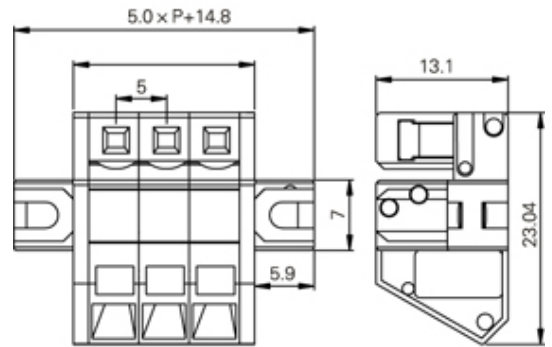

# Screwless - Push Wire

Range: PCB Terminal Blocks, Connectors and Fuse Holders

Part Number: TLM204-07P



## DESCRIPTION

7 Pole Spring - Screwless Tool operated 5mm pitch 15A 300V

*Subject to technical modification without notice.*

*Typographical and other errors do not justify claim for damages.*

## SPECIFICATION

<b>Type</b>	Spring - Screwless
<b>Connection Method</b>	Tool operated
<b>Join</b>	Solid body non stackable
<b>Pitch (mm)</b>	5
<b>Number of Poles</b>	7
<b>Max Current (A)</b>	15
<b>Max Voltage (V)</b>	300
<b>Height (mm)</b>	23.04
<b>Standard Colour</b>	grey
<b>Width (mm)</b>	13.1
<b>Length (mm)</b>	49.8
<b>Body Material</b>	PA66 V0