

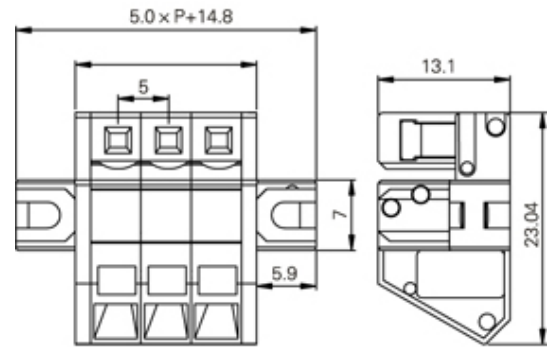

Screwless - Push Wire

Range: PCB Terminal Blocks, Connectors and Fuse Holders

Part Number: TLM204-14P



DESCRIPTION

14 Pole Spring - Screwless Tool operated 5mm pitch 15A 300V

Subject to technical modification without notice.

Typographical and other errors do not justify claim for damages.

SPECIFICATION

Type	Spring - Screwless
Connection Method	Tool operated
Join	Solid body non stackable
Pitch (mm)	5
Number of Poles	14
Max Current (A)	15
Max Voltage (V)	300
Height (mm)	23.04
Standard Colour	grey
Width (mm)	13.1
Length (mm)	84.8
Body Material	PA66 V0